



# **T-BAT-Charger**





## **Installation Manual**



## General Notice

1. Contents may be periodically updated or revised. The company reserves the right to make improvements or changes in the product(s) and the program(s) described in this manual without the prior notice.
2. The installation and maintenance can only be performed by qualified personnel who:
  - Are licensed and/or satisfy state and local jurisdiction regulations;
  - Have good knowledge of this manual and other related documents.
3. Before installing the device, carefully read, fully understand and strictly follow the detailed instruction of the user manual and other related regulations. The company shall not be liable for any consequences caused by the violation of the storage, transportation, installation, and operation regulations specified in this document and the user manual.
4. Use insulated tools when installing the device. Individual protective tools must be worn during installation, electrical connection and maintenance.

## Descriptions of Labels

	The battery module may explode		Caution, risk of electric shock
	Caution, risk of danger		Safety glasses must be worn
	Read the enclosed documentations		Keep the battery system away from children
	Keep the battery system away from open flames or ignition systems		Don't tip over the Charger when it is working.

Note: The table is only used for the description of symbols which may be used on the battery. Please be subject to the actual symbols on the device.

## General Safety Precautions

1. Do not install the Charger in places where flammable and combustible materials are stored, and in which an explosive atmosphere is present;
2. The wiring of Charger shall be carried out by qualified personnel;
3. The Charger must be serviced by qualified personal;

## Battery Handling Guide

### Do's

- DO wear complete safety goggles when charging;
- DO keep the Charger away from flammables materials, heat sources, and water sources;
- DO keep the Charger out of reach of children and animals;
- DO keep the Charger clean and dry all the time, or there may lie an electrocution hazard if the device gets wet;
- DO practice proper storage by keeping the Charger in a clean environment, free of dust, dirt and debris;
- DO store the Charger in a cool and dry place;
- DO seal the outer cable connection hole to prevent ingress of foreign objects;
- DO confirm that the wiring of the Charger must be correct;
- DO remove the Charger form the battery, make sure that the system is turned off.
- DO connect the Charger according to the local standards and regulations.

### Don'ts

- DON'T expose the Charger to an open flame, or the temperature in excess of 140°F/60°C;
- DON'T store or install the Charger in direct sunlight;
- DON'T install or operate the Charger in places where there is excessive moisture or liquids;
- DON'T place the Charger in a high-voltage environment;
- DON'T disconnect, disassemble or repair the device by unqualified personnel. Only a qualified personnel is allowed to handle, install and repair the device;
- DON'T damage the device by dropping, deforming, impacting, cutting or penetrating with a sharp object. Otherwise, it may cause a fire;
- DON'T touch the Charger when it gets hot. It may cause burns;
- DON'T step on the packaging or the device may be damaged;
- DON'T drop a tool on top of the Charger;
- DON'T charge or discharge a damaged Charger;
- DON'T dispose of the Charger in a fire. It may cause rupture, resulting in personal injury or property damage.
- DON'T tip over the Charger when it is working.



## Response to Emergency Situations

In case the battery module leaks electrolyte or any other chemical materials, or gas may be generated due to the leakage of battery module, be sure to avoid contact with the discharge at all times. In case of accidentally coming into contact with them, please do as follows:

- In case of inhalation: Leave the contaminated area immediately, and seek medical attention at once;
- In case of contact with eyes: Rinse eyes with running water for 15 minutes, and seek medical attention;
- In case of contact with skin: Wash the contacted area thoroughly with soap, and seek medical attention;
- In case of ingestion: Induce vomiting, and seek medical attention.

**If a fire breaks out where the Charger is connected, please do as follows:**

- In case the Charger is charging when the fire breaks out, provide it is safe to do so, turn off the Charger, and shut off the power charge of the battery system;
- In case the device is not on fire yet, use a Class ABC fire extinguisher or a carbon dioxide extinguisher to extinguish the fire;
- If the Charger catches fire, do not try to put out the fire, and evacuate immediately.

**Effective ways to deal with accidents**

- In case of the damaged Charger, place it into a segregated place, and call the local fire department at the place where the user lives or qualified personnel.
- If any part of the Charger, or wiring is submerged, DO stay out of the water and DON'T touch anything; If the Charger gets wet, DON'T touch it.
- If the Charger is damaged, DON'T use it. Otherwise, it may result in both personal injury and property damage.
- DON'T use the submerged Charger again, and contact the qualified personnel for assistance.
- DO contact the company immediately for assistance if the user suspects that the Charger is damaged.

## Packing List

### T-BAT-Charger

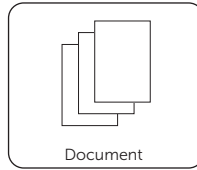
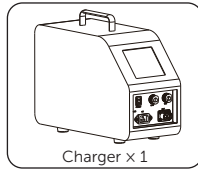
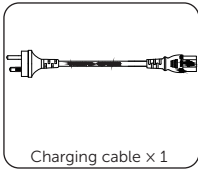
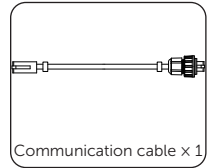
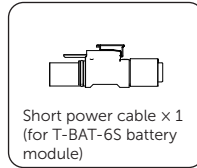
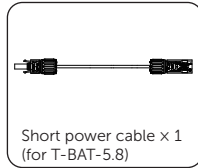
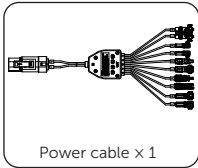

## Installation Site

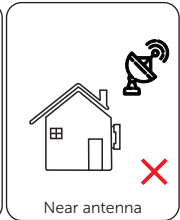
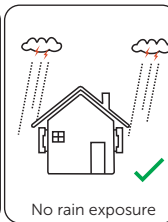
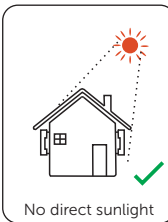
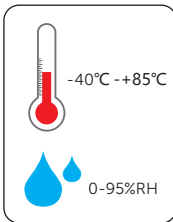

## Tools



## Technical Data

### Electrical Characteristics

Max. AC Input Apparent Power	2200 VA
Max. AC Input Current	10 A
Nominal AC Voltage (AC Voltage Range)	220 V (180~264 V)
Nominal Grid Frequency Range	47-63 Hz
Efficiency	90%
Surge Current (230 V Cold Start)	60 A
Output Voltage Range	40-150 V
Charging Current Range	0-12 A
Voltage Accuracy	1.0%
Max. Number of Batteries Supported	2 PCS

### Operating Conditions

Enclosure Protection	IP20
Operating Temperature Range	0°C to 50°C
Relative Humidity Range	20%RH to 90%RH (Non-condensing)
Storage Temperature Range	-40°C to 85°C
Storage Humidity Range	10%RH to 95%RH (Non-condensing)
Cooling Type	Smart Cooling

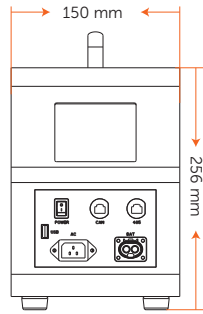

Charger	
Length	402 mm
Width	150 mm
Height	256 mm
Weight	7.1 kg

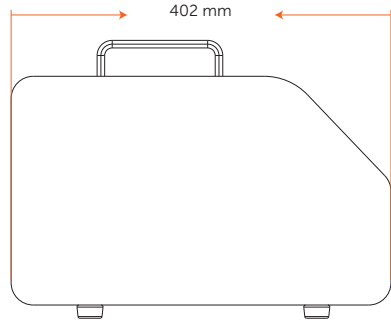

## Machine Introduction

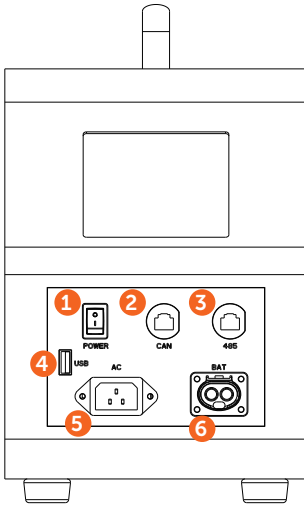

1	Power switch: To turn on/off the device
2	CAN port: To connect communication cable
3	485 port: To connect communication cable (for battery module of T-BAT-5.8 V1/V2 only)
4	USB port: To insert USB flash disk to upgrade
5	AC port: To connect charging cable
6	BAT port: To connect power cable

## Power Cable Introduction

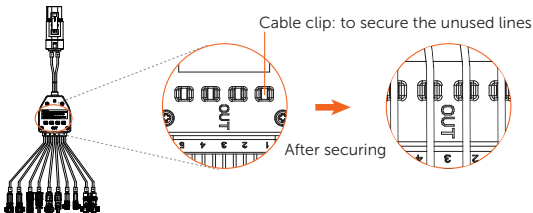
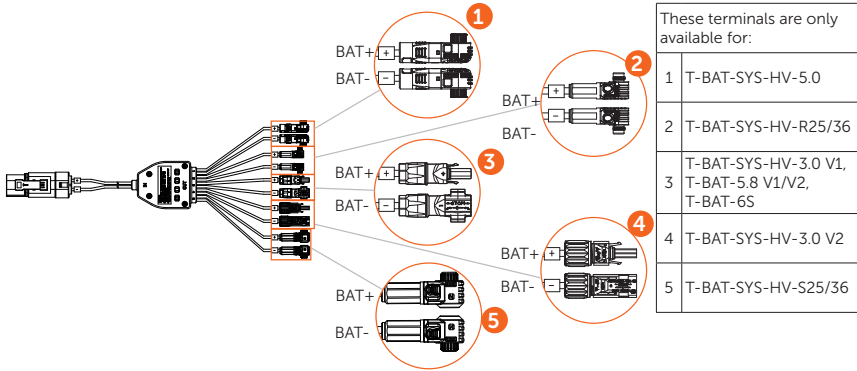

There are 4 clips on one side of the power cable, with a total of 8 clips.

Wiring Diagram between Charger and Battery

T-BAT-SYS-HV-3.0 V1

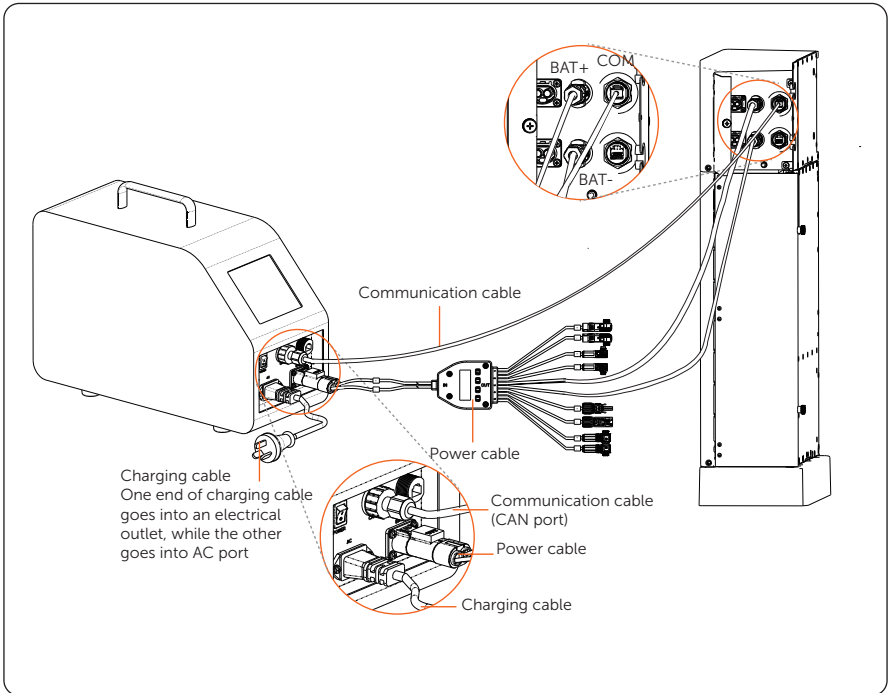

\*Note:

1. The remaining connectors on the power cable must be snapped into the cable clips. There are 4 clips on one side of the power cable, with a total of 8 clips.
2. Connectors must be protected from short-circuiting, immersion in water and moisture. Users should avoid coming into contact with the conductor materials.
3. Only one battery can be charged at once with the Charger.

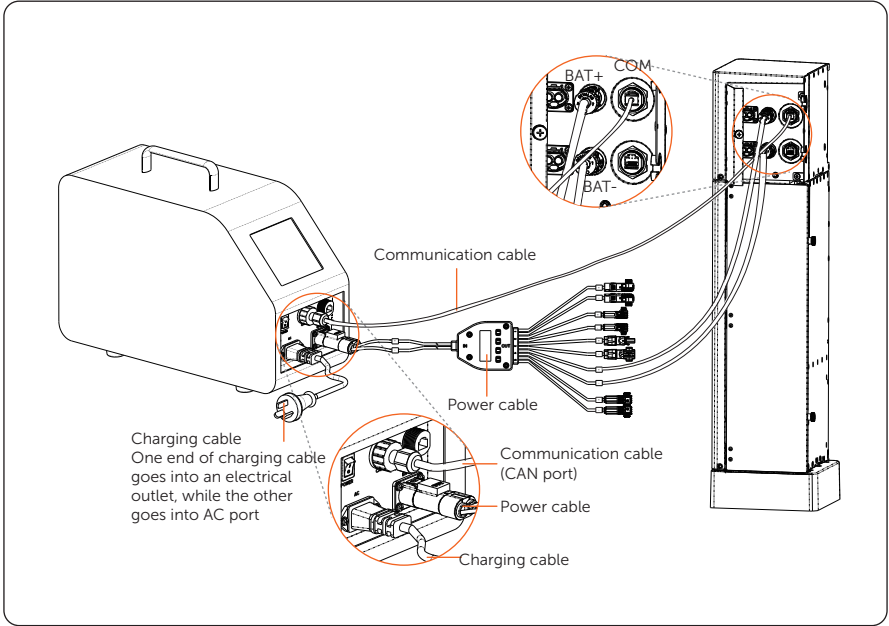

\*Note:

1. The remaining connectors on the power cable must be snapped into the cable clips. There are 4 clips on one side of the power cable, with a total of 8 clips.
2. Connectors must be protected from short-circuiting, immersion in water and moisture. Users should avoid coming into contact with the conductor materials.
3. Only one battery can be charged at once with the Charger.

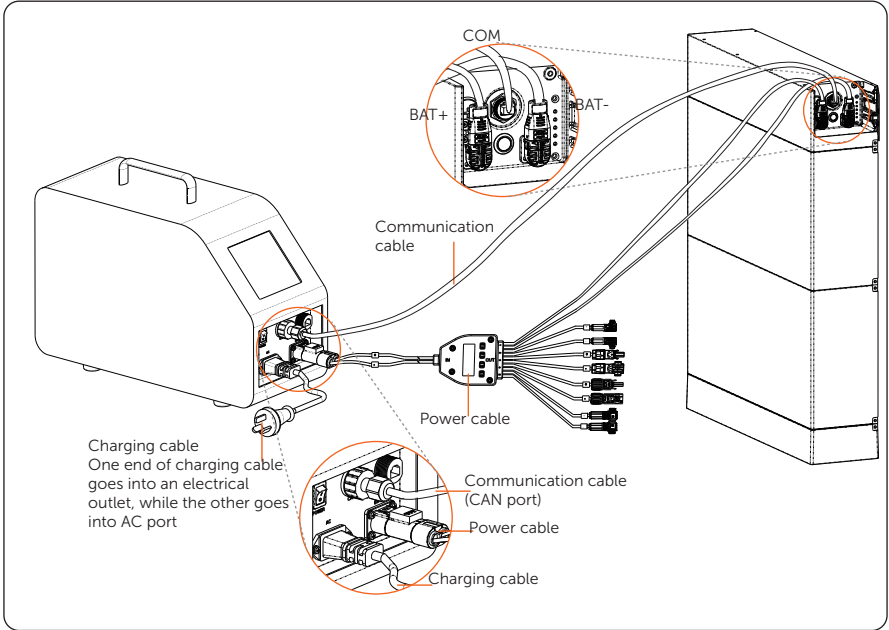

\*Note:

1. The remaining connectors on the power cable must be snapped into the cable clips. There are 4 clips on one side of the power cable, with a total of 8 clips.
2. Connectors must be protected from short-circuiting, immersion in water and moisture. Users should avoid coming into contact with the conductor materials.
3. Up to two batteries can be charged at once with the Charger.

T-BAT-5.8 V1/V2 (with BMS)

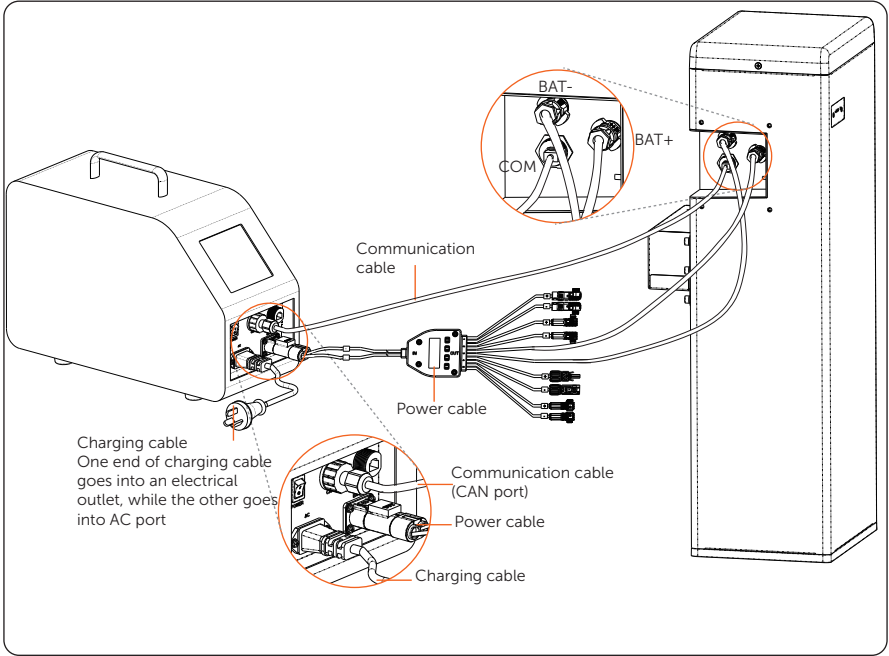

\*Note:

1. The remaining connectors on the power cable must be snapped into the cable clips. There are 4 clips on one side of the power cable, with a total of 8 clips.
2. Connectors must be protected from short-circuiting, immersion in water and moisture. Users should avoid coming into contact with the conductor materials.
3. Only one battery (T-BAT-5.8 V1/V2 with BMS) can be charged at once with the Charger.



## T-BAT-5.8 V1/V2 (without BMS)

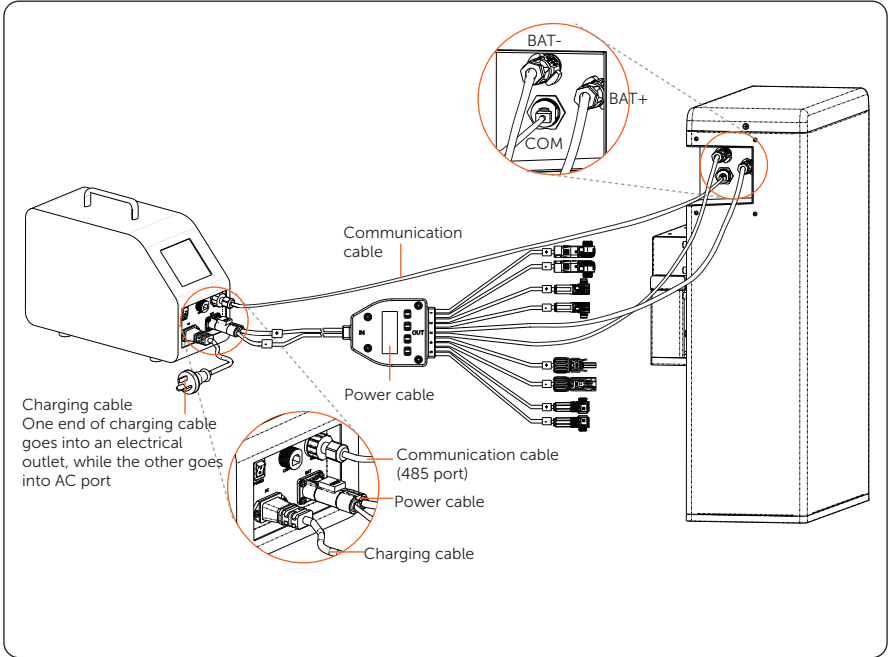

### \*Note:

1. The remaining connectors on the power cable must be snapped into the cable clips. There are 4 clips on one side of the power cable, with a total of 8 clips.
2. Connectors must be protected from short-circuiting, immersion in water and moisture. Users should avoid coming into contact with the conductor materials.
3. Only one battery (T-BAT-5.8 V1/V2 without BMS) can be charged at once with the Charger.

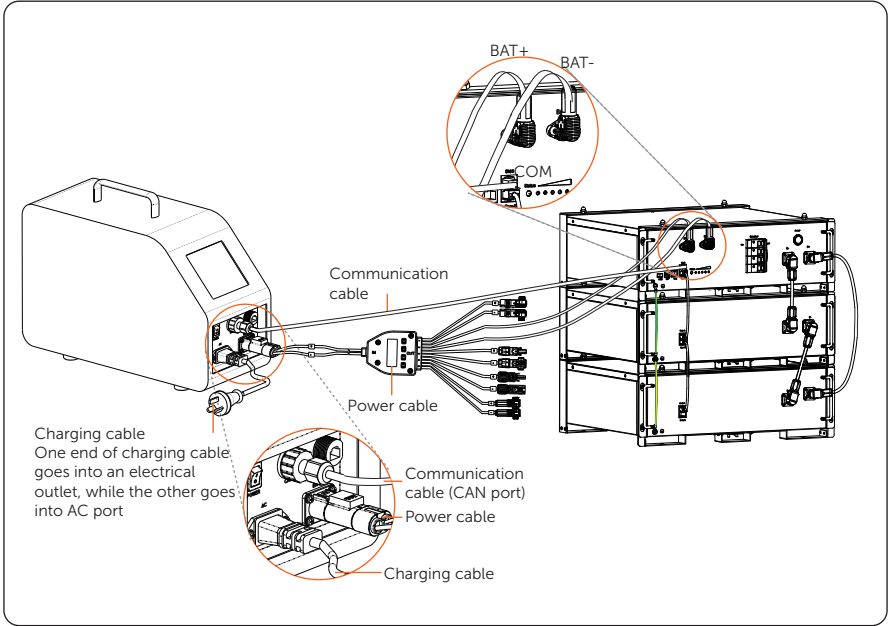

\*Note:

1. The remaining connectors on the power cable must be snapped into the cable clips. There are 4 clips on one side of the power cable, with a total of 8 clips.
2. Connectors must be protected from short-circuiting, immersion in water and moisture. Users should avoid coming into contact with the conductor materials.
3. Up to two batteries can be charged at once with the Charger.

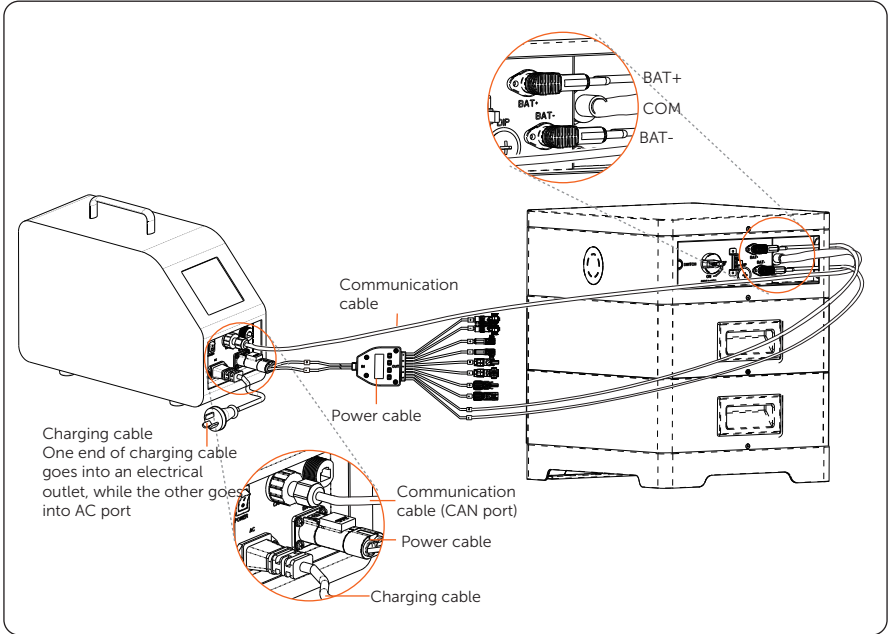

\*Note:

1. The remaining connectors on the power cable must be snapped into the cable clips. There are 4 clips on one side of the power cable, with a total of 8 clips.
2. Connectors must be protected from short-circuiting, immersion in water and moisture. Users should avoid coming into contact with the conductor materials.
3. Up to two batteries can be charged at once with the Charger.

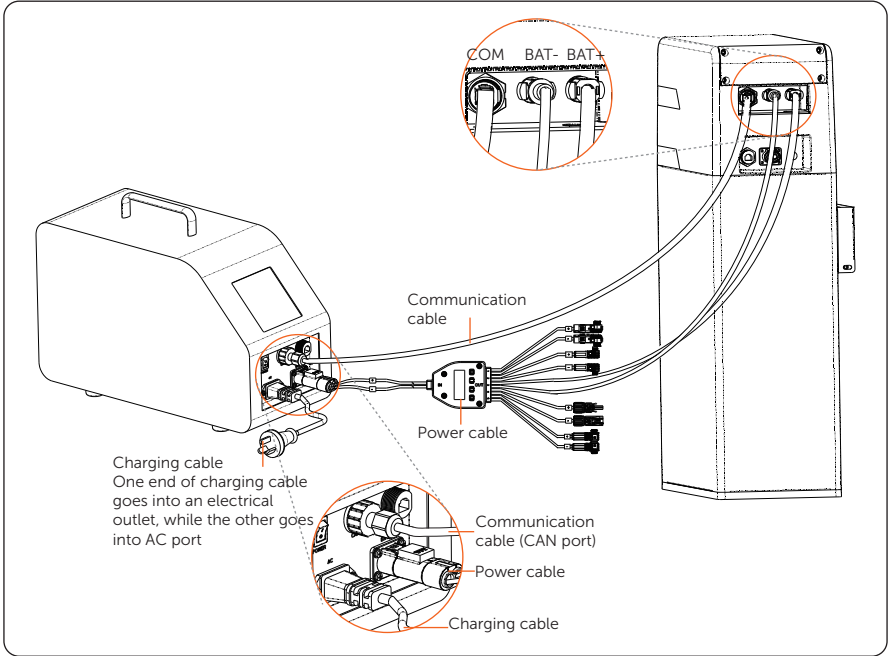

**\*Note:**

1. The remaining connectors on the power cable must be snapped into the cable clips. There are 4 clips on one side of the power cable, with a total of 8 clips.
2. Connectors must be protected from short-circuiting, immersion in water and moisture. Users should avoid coming into contact with the conductor materials.
3. Only one battery can be charged at once with the Charger.

**Power on the System**

After finishing the wiring, toggle the "POWER" switch to start the Charger.

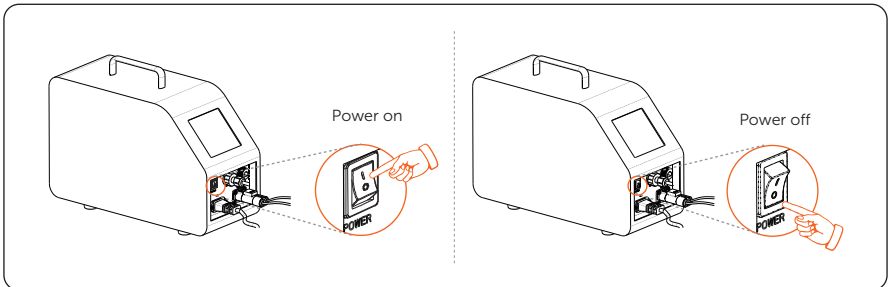

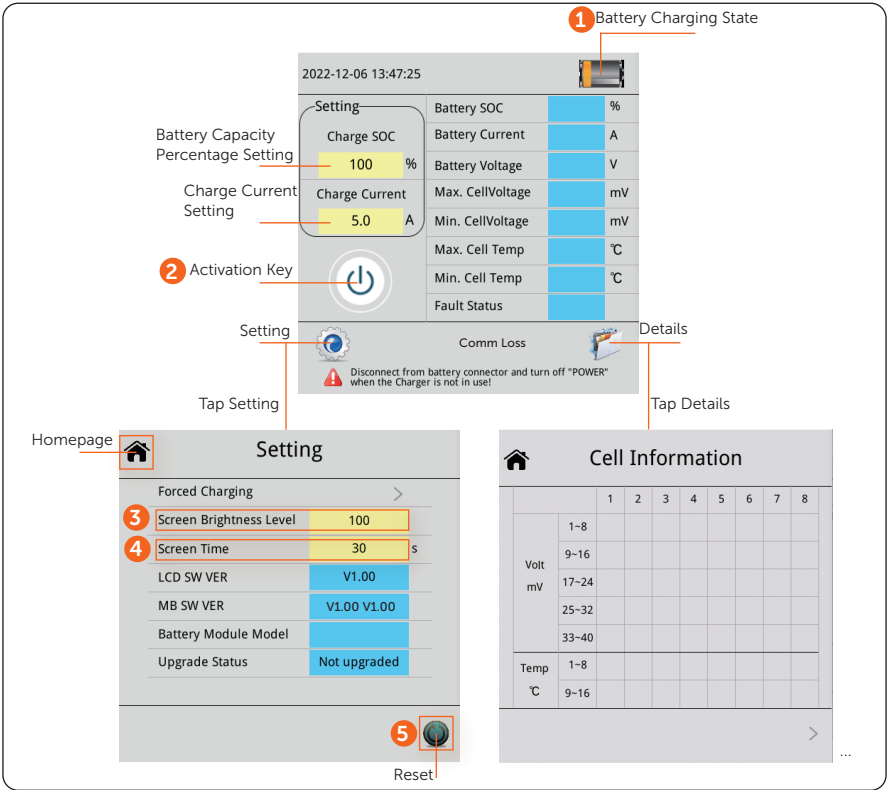

\*Note:

1. Battery Charging State: If the icon is green and the green light cycles, the device is charging. Otherwise, it is not charging.
2. Activation Key: If the Key snaps and the colour shows white, the device will stop charging; if the Key is pressed and the colour shows yellow, the device will start charging.
3. Screen Brightness Level: The screen brightness can be manually adjusted by the user, with a level of 0 to 100.
4. Screen Time: The screen time also can be adjusted by the user, with a time range of 30 to 240 seconds.

### Forced Charging

The Charger supports the function of "forced charging," and the function requires a password to start.

1. Tap the "Setting", and the user will see the "Forced Charging";
2. Tap the "Forced Charging";
3. Enter a password;

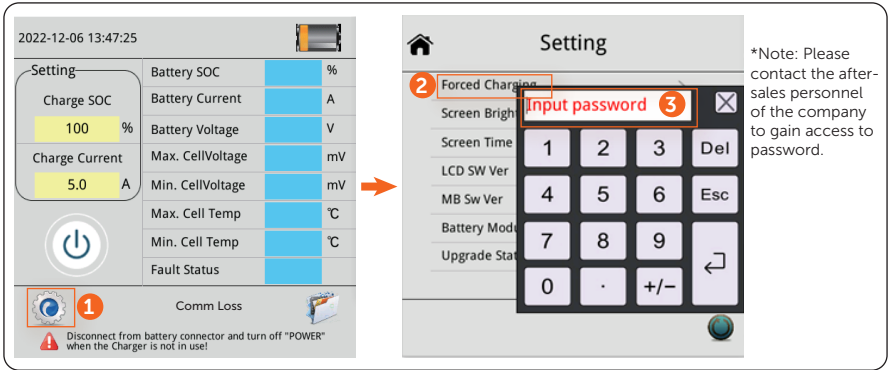

4. Tap to set a time limit for 5 minutes to 15 minutes before charging. The default time limit is 5 minutes;

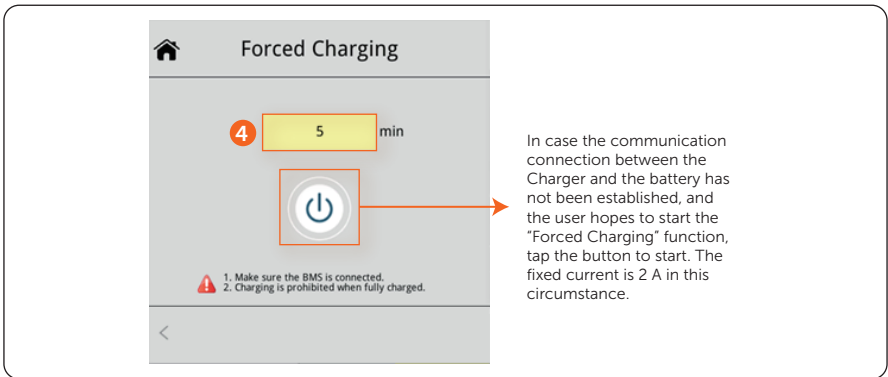

\*Note: The "Forced Charging" must be disabled in case of the following circumstances:

1. The ambient temperature is below 0°C or over 55°C;
2. 100% SOC

In the following circumstances, the "Forced Charging" will be stopped:

- Time's up;
- Battery fault;
- Communication between the Charger and battery is established;
- Tap the button.

## Upgrade

The Charger supports the function "Upgrade". If a user wants to upgrade the device,

1. Please contact the after-sales personnel of the company to obtain the Upgrade File;
2. Copy such File to a USB Flash Disk (USB 2.0 or later is required);
3. Insert the USB Flash Disk, tap "Yes" to jump to "Reset" page, and then you're off to the races.

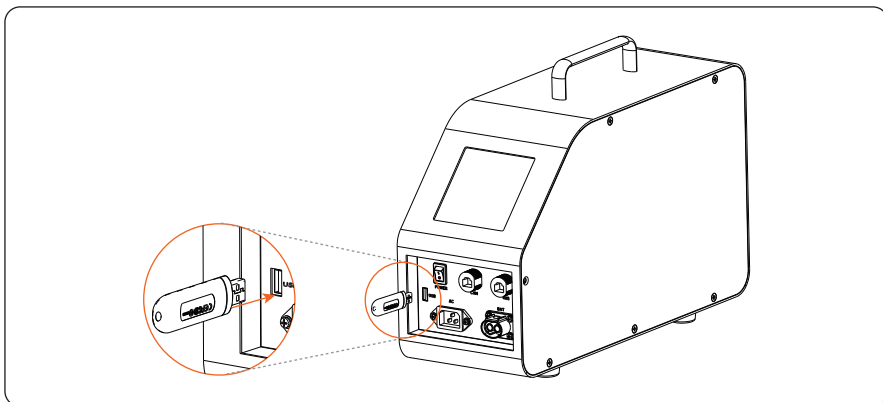

\*Note: The above-mentioned USB flash disk will not be provided by the company.

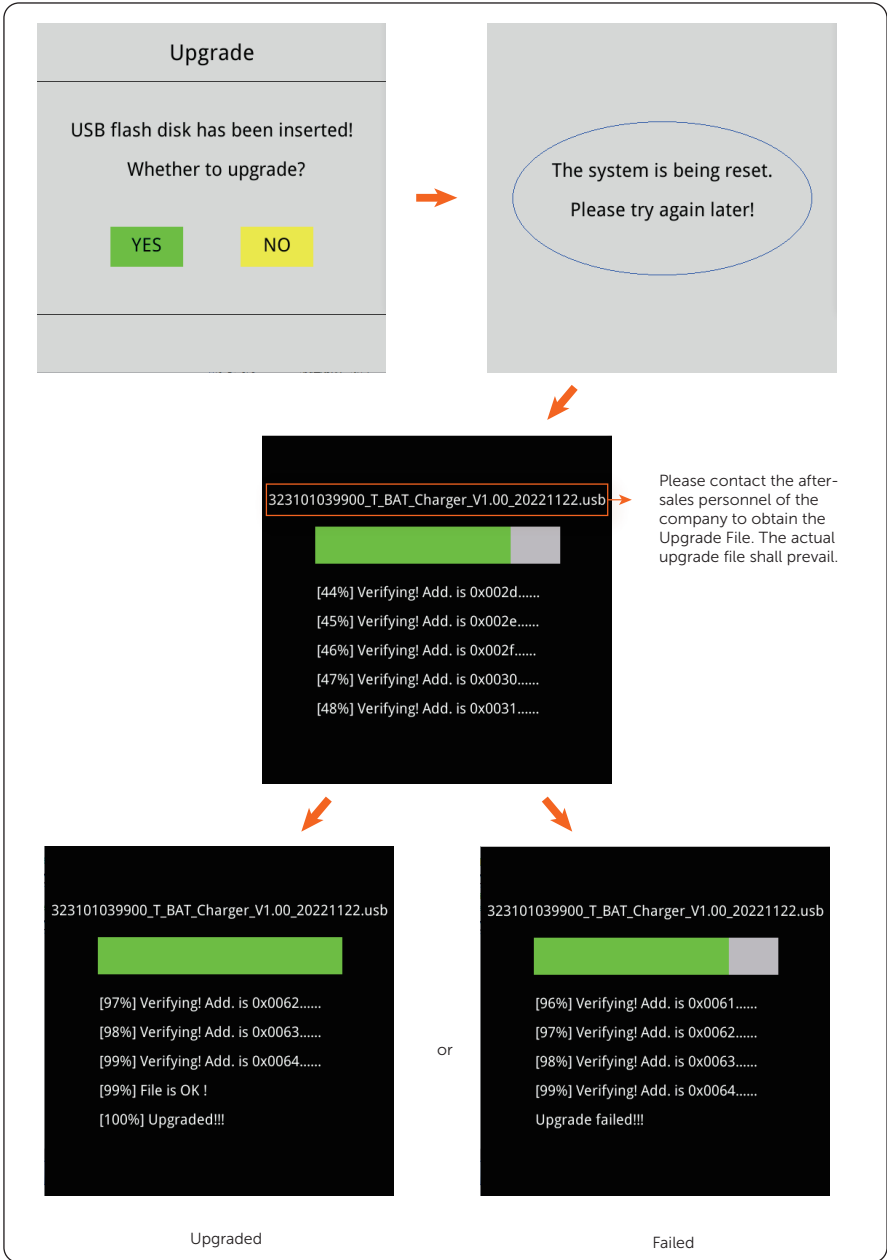

\*Note: Please DON'T shut down the device, DON'T remove the USB flash disk, and DO keep it plugged in all the time while upgrading, or the upgrade will fail.







320102067601